

# Diverter Valve - Manual or Automatic

## Ordering Information

- When ordering, specify material (Mild Steel or SS), gauge (if non-standard), dimension, end styles, choice of Manual or Automatic Open / Close and, if Automatic, control circuit voltage.
- High efficiency, economical method of diverting flow of material or air.
- Housing is heavy duty construction of painted 3/16" thick mild steel with welded seams. Heavy duty flange bearings and rubber seal in 14ga steel door. Rubber seal is 1/4" thick polymer compound #AB-3205.
- Auto: Standard 120V control circuit and 75psi minimum air pressure. Optional 24V DC control circuit available.
- Auto Diverter Valves have single magnetic cylinders with galvanized or SS body and steel rod. Solenoid has plastic housing.
- 45° only.



Ø in.	A in.	B in.	Length in.	Manual Std Weight lbs	Auto Std Weight lbs
3	6	14	26	15.00	22.50
4	6	14	26	20.00	27.00
5	6	15.25	27.25	30.00	37.50
6	6	16	28	44.00	51.00
7	6	16	28	60.00	67.50
8	6	17	29	66.50	74.00
9	8	18	34	85.40	92.90
10	8	20	36	100.00	107.50
11	8	20	36	115.00	140.00
12	8	24	40	130.00	154.00
13	8	24	40	146.50	177.50
14	8	28	44	170.00	198.50
15	8	28	44	190.00	227.40
16	8	32	48	220.00	260.00
17	8	32	48	337.00	345.00
18	8	36	52	392.00	400.00
20	10	40	60	447.00	455.00
22	10	41.25	61.25	522.50	530.00
24	10	48	68	625.10	635.00

Other sizes available upon request.

## QF Material Options

Galv (Collar)				SS			
Gauges	Size (inches)		Gauges	Size (inches)			
	Min. Ø	Max. Ø		Min. Ø	Max. Ø		
Standard	22	3	12	Standard	22	3	12
	20	13	24		20	13	24
Optional	18	4	24	Optional	18	8	24
	16	8	24		16	8	24

## Flanged Material Options

Galv (Collar)				SS			
Gauges	Size (inches)		Gauges	Size (inches)			
	Min. Ø	Max. Ø		Min. Ø	Max. Ø		
Standard	22	3	12	Standard	22	3	12
	20	13	24		20	13	24
Optional	18	4	24	Optional	18	8	24
	14	8	24		16	8	24

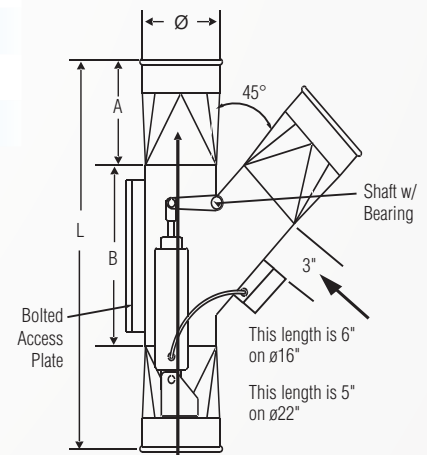
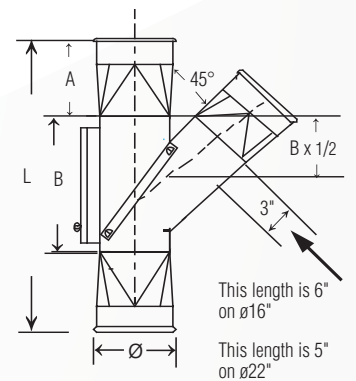

Additional Product Components and Notes				
Poly tube	0.25" OD x 0.04 wall poly tube, 120 PSI, Grade E5 LIP, Type 1			
Roller Bearing	Valve Size	Mfr. Part No. (Powerite)		
	4" - 6"	UCFL 204-12		
	7" - 16"	UCFL 205-16		
	18" - 24"	UCFL 206-20		
Magnetic Cylinder	Valve Size	Stroke	No. of Cylinders	Bore
	3" - 8"	2.25 x 4.00	1	2.5"
	9" - 12"	2.25 x 6.00		
	13" - 16"	2.25 x 8.00		
	17" - 24"	2.25 x 10.00		
Double Solenoid Options	<ul style="list-style-type: none"> <li>• 2 position, 110VAC, 2.5 watts, 1/8" NPT, IP65 Rated</li> <li>• 2 position, 24VDC, .35 watts, 1/8" NPT, IP65 Rated</li> </ul>			
Coil Options	<ul style="list-style-type: none"> <li>• 24VDC</li> <li>• 12VDC</li> <li>• 240VAX</li> <li>• 110VAC</li> </ul>			

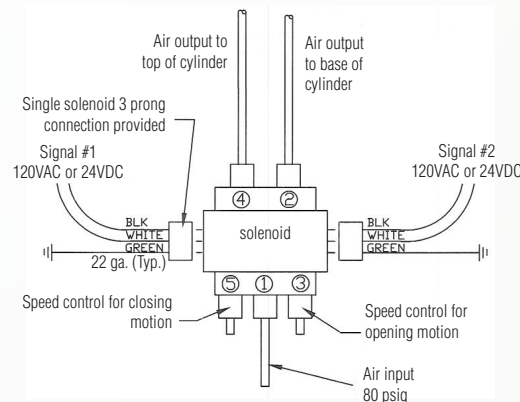

◇ Diverter Valves have a lead time of **7 days** minimum